

Magnetic Heads 8011

Mágnesfejek Magnetköpfe

Type / Típus / Typ: 8011

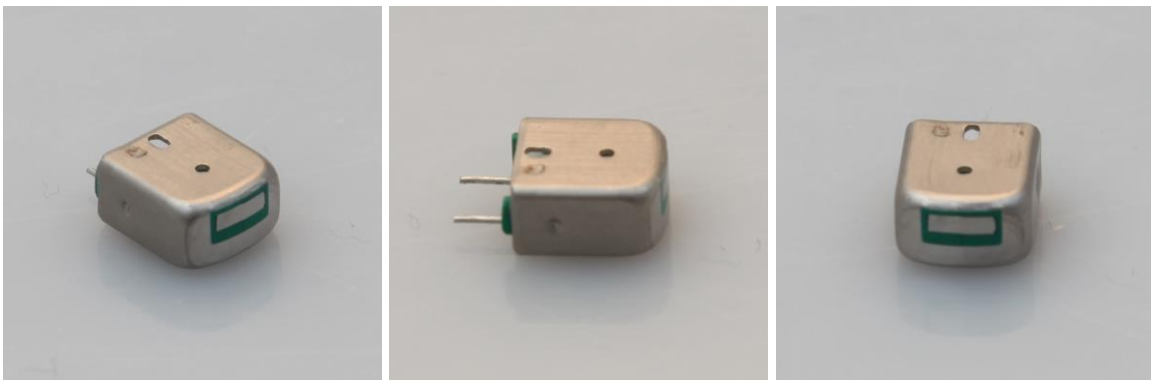
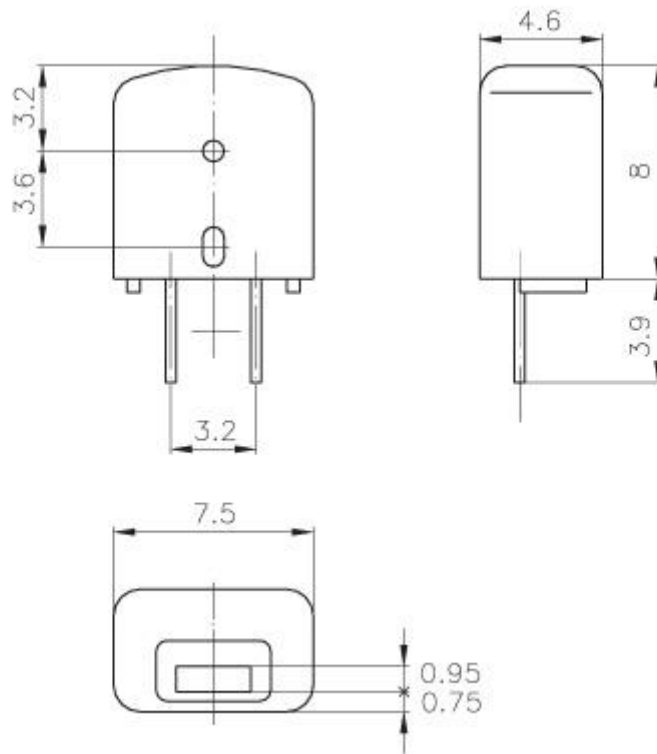

For cass. tape		
Function / monó /		recording/play-back
Inductance (10 kHz, 50 mV)	mH	40±20%
Play-back with BASF IEC 94/2 reference tape		
Measuring frequency	Hz	6.3 k, 315
Sensitivity (315 Hz)	μV	min.:215
Frequency response (6.3k / 315 Hz)	dB	min.:4
Measuring the recording and play-back funktion with IEC (R723DG) tape from BASF		
Bias frequency	kHz	28
Bias current	μA	550±30%
Recording current (1 kHz)	μA	180
Sensitivity (315 Hz)	μV	min.:140
Rec. and play-back freq. response (6.3k / 315 Hz)	dB	min.: 0
Totally harmonic distortion (1 kHz)	%	max.:11
Insulation resistance (250 V DC)	MΩ	min.:10
Resistance between magn. core and case (5 V DC)	kΩ	max.:50
Tape speed	cm/s	4.75
Pole material		Recovac BS